

# Aetnastak<sup>®</sup>

## Cantilever Library Shelving Systems

storage optimized



**MONTEL<sup>®</sup>**  
The Intelligent Use of Space





AETNASTAK®, A SOLID REFERENCE for experts in the industry. Aetnastak® can address your current and future needs at the same time. This cantilever shelving system offers a wide range of accessories and practical features. Sections can be reconfigured, lengthened, shortened, relocated, or joined to existing units easily and without adding any extra parts. Montel offers products that adapt to all types of media (audiovisual material, CD, DVD, etc.).

In addition to Aetnastak’s elegance, strength, rigidity, and safety features, the **welded frame** construction is designed to meet seismic requirements.

Moreover, people appreciate the design details. The four-bend edges eliminate roughness while reinforcing the shelves. The closed uprights protect books and conceal electrical wiring safely and discreetly.

Whether fixed or installed on Montel mobile carriages, Aetnastak offers unlimited possibilities.

BOOKSTACK ASSEMBLY	2
SAFETY AND RELIABILITY	3
FLEXIBILITY	4
AESTHETICS	4
CLOSED BASE SHELVING	5-6
DIVIDER TYPE SHELVING	7-8
PERIODICAL SHELVING	9-10
CONTEMPORARY UNITS	11
END PANELS AND CANOPY TOPS	12-14
COMPONENTS	15
WELDED FRAMES AND GUSSETS (SEISMIC ZONES)	16
SHELVES	17-23
ACCESSORIES	24-27

# MONTEL AETNASTAK ADVANTAGES

## BOOKSTACK ASSEMBLY

### ACTUAL VS NOMINAL DIMENSIONS

Please notice that dimensions in this catalog are either actual or nominal. For library nominal dimensions, add 1" to the actual depth.

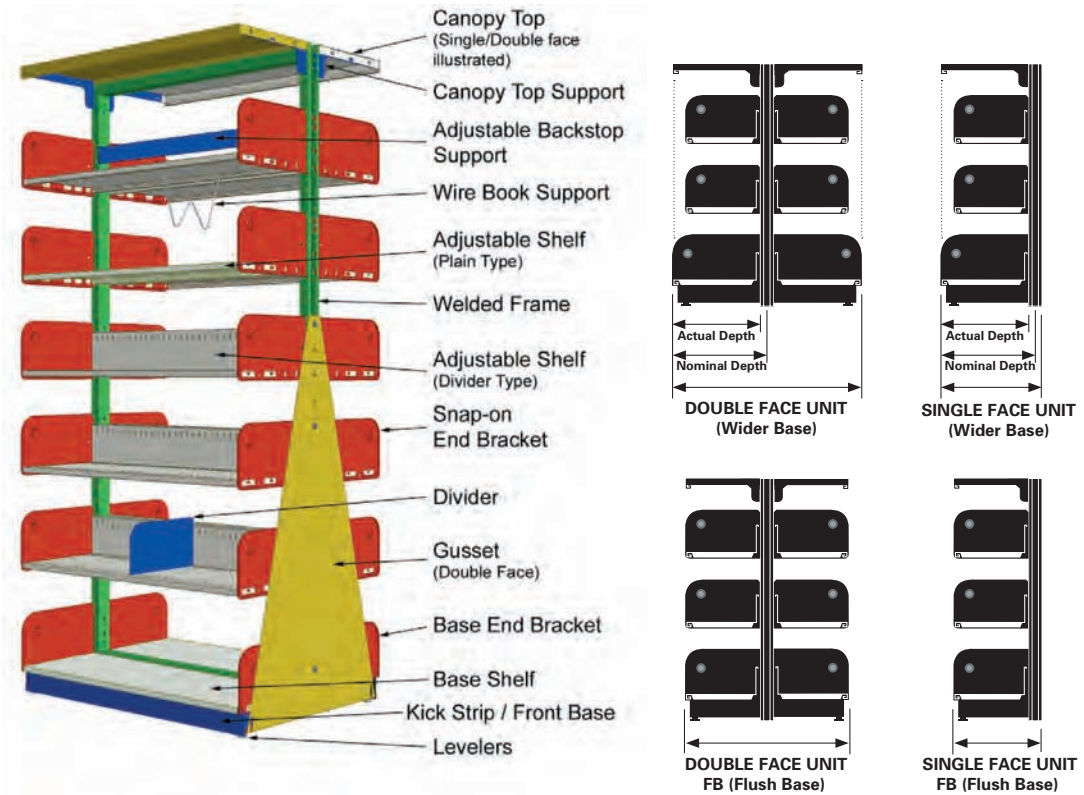

- Actual Depth..... Real depth dimension
- Adjustable Shelf..... Shelf with SNAP-ON END BRACKETS
- Adjustable Shelf (Divider Type)..... Slotted shelves with SNAP-ON END BRACKETS to accommodate DIVIDERS
- Adjustable Backstop Support ..... Adjustable backstop used with plain shelves
- Base End Bracket ..... Brackets supporting BASE SHELF
- Base Shelf..... Shelf with BASE END BRACKETS, KICK STRIP and LEVELERS
- Canopy Top ..... Top shelf with CANOPY TOP SUPPORTS (included)
- Canopy Top Support..... Brackets supporting CANOPY TOP
- Divider ..... Adjustable partition
- Double Face..... Unit with shelves on both sides
- Gusset..... For seismic areas and if reinforcement is required
- Kick Strip / Front Base ..... Front base (standard black color)
- Levelers ..... Adjustable leveling feet (included with each unit)
- Nominal Depth..... Depth from the center of the VERTICAL UPRIGHT to the shelf front edge
- Single Face..... Unit with shelves on one side
- Snap-on End Bracket ..... Brackets supporting ADJUSTABLE SHELF
- Welded Frame..... One UPRIGHT FRAME with cross members welded together
- Wire Book Support ..... Adjustable book support underneath shelf

## SAFETY AND RELIABILITY

### • **Features**

#### ▪ **Benefits**

- Frames are welded
  - Provides strength and rigidity
- Base shelves are flush with the top surface of the bottom spreader channel
  - Provides a continuous storage surface
- Shelves will support 50 lbs. per lineal foot or 244 kg per square meter
  - Meets and exceeds Library Technology Report approved requirements
- Shelf edges have a fourth bend at the front and the back
  - Increases strength and eliminates sharp edges
  - Reduces risk of injuries



Fourth bend



Enclosed tube

- Shelf brackets have a radial edge
  - Protects books from being damaged when reshelving
- Connected frames form an enclosed tube
  - Prevents books from being inserted within the tube and being damaged
  - Allows electrical wire to be concealed within the post when needed
- Meets and exceeds the Uniform Building Code (UBC) requirements for seismic zones
  - Ensures user's safety in case of earthquakes

# MONTEL AETNASTAK ADVANTAGES

## FLEXIBILITY

### • *Features*

#### ▪ *Benefits*

- Stacks can be modified from double faced to single faced or vice-versa by removing or adding shelves on one side of the stack. Shelves are easily adjustable without using any tools
  - Allows total flexibility for future expansion or reorganisation
- Free standing shelving can be removed from a range and used elsewhere without adding parts
  - The system can be easily relocated
- Adjustable threaded levelers
  - Ensures stability on an uneven floor
- Kick strips adjust vertically and are recessed under the bottom shelf to provide toe space
  - Provides toe space and clean appearance

## AESTHETICS

- Solely a powder coat finish. Different standard colors available (see color chart). Custom color match for an additional charge
  - Design integration
- End panels are supplied in textured steel unless otherwise specified. Textured steel end panels have a clean leather like appearance to give a stylish finish to your steel shelving. Also available in wood veneer, plastic laminate melamine and standard steel
  - Provides a pleasing look

# CLOSED BASE SHELVING SINGLE FACED



Catalog No.	Nominal Shelf Depth	Nominal Base Shelf Depth	Overall Unit Depth
-------------	---------------------	--------------------------	--------------------

## 42" HIGH 2 ADJUSTABLE SHELVES 1 BASE SHELF



L423608FB	8"	8"	9 3/8"
L423608	8"	10"	11 3/8"
L423609FB	9"	9"	10 3/8"
L423609	9"	10"	11 3/8"
L423610FB	10"	10"	11 3/8"
L423610	10"	12"	13 3/8"
L423612FB	12"	12"	13 3/8"

## 66" HIGH 4 ADJUSTABLE SHELVES 1 BASE SHELF



L663608FB	8"	8"	9 3/8"
L663608	8"	10"	11 3/8"
L663609FB	9"	9"	10 3/8"
L663609	9"	10"	11 3/8"
L663610FB	10"	10"	11 3/8"
L663610	10"	12"	13 3/8"
L663612FB	12"	12"	13 3/8"

## 78" HIGH 5 ADJUSTABLE SHELVES 1 BASE SHELF



L783608FB	8"	8"	9 3/8"
L783608	8"	10"	11 3/8"
L783609FB	9"	9"	10 3/8"
L783609	9"	10"	11 3/8"
L783610FB	10"	10"	11 3/8"
L783610	10"	12"	13 3/8"
L783612FB	12"	12"	13 3/8"

## 84" HIGH 6 ADJUSTABLE SHELVES 1 BASE SHELF



L843608FB	8"	8"	9 3/8"
L843608	8"	10"	11 3/8"
L843609FB	9"	9"	10 3/8"
L843609	9"	10"	11 3/8"
L843610FB	10"	10"	11 3/8"
L843610	10"	12"	13 3/8"
L843612FB	12"	12"	13 3/8"

## 90" HIGH 6 ADJUSTABLE SHELVES 1 BASE SHELF



L903608FB	8"	8"	9 3/8"
L903608	8"	10"	11 3/8"
L903609FB	9"	9"	10 3/8"
L903609	9"	10"	11 3/8"
L903610FB	10"	10"	11 3/8"
L903610	10"	12"	13 3/8"
L903612FB	12"	12"	13 3/8"

NOTE: • All single faced units must be anchored to the wall.  
 • 24" and 30" widths available. Substitute 24" and 30" in catalog number when required.  
 • Shelf and base depth dimensions are nominal. For actual dimensions, deduct 1" to the nominal depth.  
 • The picture is for reference only and the quantity of shelf may vary.

# CLOSED BASE SHELVING

## DOUBLE FACED



### 42" HIGH



Catalog No.	Nominal Shelf Depth	Nominal Base Shelf Depth	Overall Unit Depth
<b>4 ADJUSTABLE SHELVES 2 BASE SHELVES</b>			

L423616FB	8"	8"	16 3/4"
L423616	8"	10"	20 3/4"
L423618FB	9"	9"	18 3/4"
L423618	9"	10"	20 3/4"
L423620FB	10"	10"	20 3/4"
L423620	10"	12"	24 3/4"
L423624FB	12"	12"	24 3/4"

### 66" HIGH

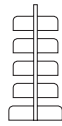

<b>8 ADJUSTABLE SHELVES 2 BASE SHELVES</b>			
--	--	--	--

L663616FB	8"	8"	16 3/4"
L663616	8"	10"	20 3/4"
L663618FB	9"	9"	18 3/4"
L663618	9"	10"	20 3/4"
L663620FB	10"	10"	20 3/4"
L663620	10"	12"	24 3/4"
L663624FB	12"	12"	24 3/4"

### 78" HIGH

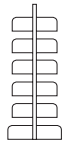

<b>10 ADJUSTABLE SHELVES 2 BASE SHELVES</b>			
---	--	--	--

L783616FB*	8"	8"	16 3/4"
L783616	8"	10"	20 3/4"
L783618FB*	9"	9"	18 3/4"
L783618	9"	10"	20 3/4"
L783620FB*	10"	10"	20 3/4"
L783620	10"	12"	24 3/4"
L783624FB	12"	12"	24 3/4"

### 84" HIGH

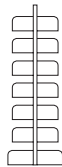

<b>12 ADJUSTABLE SHELVES 2 BASE SHELVES</b>			
---	--	--	--

L843616FB*	8"	8"	16 3/4"
L843616	8"	10"	20 3/4"
L843618FB*	9"	9"	18 3/4"
L843618	9"	10"	20 3/4"
L843620FB*	10"	10"	20 3/4"
L843620	10"	12"	24 3/4"
L843624FB	12"	12"	24 3/4"

### 90" HIGH

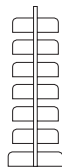

<b>12 ADJUSTABLE SHELVES 2 BASE SHELVES</b>			
---	--	--	--

L903616FB*	8"	8"	16 3/4"
L903616	8"	10"	20 3/4"
L903618FB*	9"	9"	18 3/4"
L903618	9"	10"	20 3/4"
L903620FB*	10"	10"	20 3/4"
L903620	10"	12"	24 3/4"
L903624FB	12"	12"	24 3/4"

- NOTE:
- Units with an asterisk after the catalog number must be anchored to the floor or with top tie strut.
  - 24" and 30" widths available. Substitute 24" and 30" in catalog number when required.
  - Shelf and base depth dimensions are nominal. For actual dimensions, deduct 1" to the nominal depth.
  - The picture is for reference only and the quantity of shelf may vary.





# DIVIDER TYPE SHELVING

## SINGLE FACED





Catalog No.	Actual Shelf Depth	Actual Base Shelf Depth	Overall Unit Depth
-------------	--------------------	-------------------------	--------------------

42" HIGH	2 ADJUSTABLE SHELVES 1 BASE SHELF		
 S423609FB	9"	9"	11 3/8"
S423609	9"	11"	13 3/8"
S423611FB	11"	11"	13 3/8"
S423613	13"	15"	17 3/8"

48" HIGH	2 ADJUSTABLE SHELVES 1 BASE SHELF		
 S483609FB	9"	9"	11 7/32"
S483609	9"	11"	13 7/32"
S483611FB	11"	11"	13 7/32"
S483613	13"	15"	17 7/32"

66" HIGH	4 ADJUSTABLE SHELVES 1 BASE SHELF		
 S663609FB	9"	9"	11 3/8"
S663609	9"	11"	13 3/8"
S663611FB	11"	11"	13 3/8"
S663613	13"	15"	17 3/8"

78" HIGH	5 ADJUSTABLE SHELVES 1 BASE SHELF		
 S783609FB	9"	9"	11 3/8"
S783609	9"	11"	13 3/8"
S783611FB	11"	11"	13 3/8"
S783613	13"	15"	17 3/8"

84" HIGH	6 ADJUSTABLE SHELVES 1 BASE SHELF		
 S843609FB	9"	9"	11 3/8"
S843609	9"	11"	13 3/8"
S843611FB	11"	11"	13 3/8"
S843613	13"	15"	17 3/8"

90" HIGH	6 ADJUSTABLE SHELVES 1 BASE SHELF		
 S903609FB	9"	9"	11 3/8"
S903609	9"	11"	13 3/8"
S903611FB	11"	11"	13 3/8"
S903613	13"	15"	17 3/8"

93" HIGH	7 ADJUSTABLE SHELVES 1 BASE SHELF		
 S933609FB	9"	9"	11 3/8"
S933609	9"	11"	13 3/8"
S933611FB	11"	11"	13 3/8"
S933613	13"	15"	17 3/8"

NOTE:

- Dividers not included.
- All single faced units must be anchored to the wall.
- Shelves are slotted on 1" centers for dividers and have a 5" high back.
- Shelf and base depth dimensions are actual. For nominal dimensions, add 1" to the actual depth.
- The picture is for reference only and the quantity of shelf may vary.

# DIVIDER TYPE SHELVING

## DOUBLE FACED



Catalog No.	Actual Shelf Depth	Actual Base Shelf Depth	Overall Unit Depth	
<b>42" HIGH</b>				
<b>4 ADJUSTABLE SHELVES 2 BASE SHELVES</b>				
	S423618FB	9"	9"	20 3/4"
	S423618	9"	11"	24 3/4"
	S423622FB	11"	11"	24 3/4"
	S423626	13"	15"	32 3/4"
<b>48" HIGH</b>				
<b>4 ADJUSTABLE SHELVES 2 BASE SHELVES</b>				
	S483618FB	9"	9"	20 3/4"
	S483618	9"	11"	24 3/4"
	S483622FB	11"	11"	24 3/4"
	S483626	13"	15"	32 3/4"
<b>66" HIGH</b>				
<b>8 ADJUSTABLE SHELVES 2 BASE SHELVES</b>				
	S663618FB	9"	9"	20 3/4"
	S663618	9"	11"	24 3/4"
	S663622FB	11"	11"	24 3/4"
	S663626	13"	15"	32 3/4"
<b>78" HIGH</b>				
<b>10 ADJUSTABLE SHELVES 2 BASE SHELVES</b>				
	S783618FB	9"	9"	20 3/4"
	S783618	9"	11"	24 3/4"
	S783622FB	11"	11"	24 3/4"
	S783626	13"	15"	32 3/4"
<b>84" HIGH</b>				
<b>12 ADJUSTABLE SHELVES 2 BASE SHELVES</b>				
	S843618FB	9"	9"	20 3/4"
	S843618	9"	11"	24 3/4"
	S843622FB	11"	11"	24 3/4"
	S843626	13"	15"	32 3/4"
<b>90" HIGH</b>				
<b>12 ADJUSTABLE SHELVES 2 BASE SHELVES</b>				
	S903618FB	9"	9"	20 3/4"
	S903618	9"	11"	24 3/4"
	S903622FB	11"	11"	24 3/4"
	S903626	13"	15"	32 3/4"
<b>93" HIGH</b>				
<b>14 ADJUSTABLE SHELVES 2 BASE SHELVES</b>				
	S933618FB	9"	9"	20 3/4"
	S933618	9"	11"	24 3/4"
	S933622FB	11"	11"	24 3/4"
	S933626	13"	15"	32 3/4"

- NOTE:
- Dividers not included.
  - Shelves are slotted on 1" centers for dividers and have a 5" back.
  - All double faced units 78" and over must be anchored to the floor or with a top tie strut.
  - Shelf and base depth dimensions are actual. For nominal dimensions, add 1" to the actual depth.
  - These units are sold with 5 dividers 6" high per shelf
  - The picture is for reference only and the quantity of shelf may vary.

## FIXED PERIODICAL DISPLAY AND STORAGE UNITS



Catalog No.	Height	No. Display Shelves	No. Storage Shelves	Overall Unit Depth
<b>SINGLE FACED</b>				
LPF42	42"	2	1	13 3/8"
LPF66	66"	3	2	13 3/8"
LPF78	78"	4	3	13 3/8"
LPF90	90"	5	4	13 3/8"

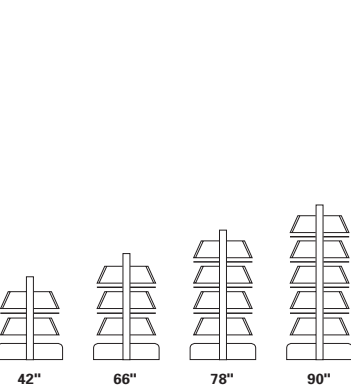

Catalog No.	Height	No. Display Shelves	No. Storage Shelves	Overall Unit Depth
<b>DOUBLE FACED</b>				
LPF42DF	42"	4	2	24 3/8"
LPF66DF	66"	6	4	24 3/8"
LPF78DF	78"	8	6	24 3/8"
LPF90DF	90"	10	8	24 3/8"

- NOTE:
- Display surface is 11" high.
  - All units include shelves and base of 11" actual, for nominal dimension, add 1" to the actual depth.
  - The picture is for reference only and the quantity of shelf may vary.

## HINGED PERIODICAL DISPLAY AND STORAGE UNITS



Catalog No.	Height	Display & Storage Shelves	No. Base	Overall Unit Depth
<b>SINGLE FACED</b>				
LPH42-2	42"	1	1	13 3/8"
LPH66-4	66"	3	1	13 3/8"
LPH78-5	78"	4	1	13 3/8"
LPH90-6	90"	5	1	13 3/8"

Catalog No.	Height	Display & Storage Shelves	No. Bases	Overall Unit Depth
<b>DOUBLE FACED</b>				
LPH42-4DF	42"	2	2	24 3/8"
LPH66-8DF	66"	6	2	24 3/8"
LPH78-10DF	78"	8	2	24 3/8"
LPH90-12DF	90"	10	2	24 3/8"

- NOTE:
- Display surface is 14" high.
  - The storage shelves are 11" actual, for nominal dimension, add 1" to the actual depth.
  - The picture is for reference only and the quantity of shelf may vary.

# SLOPED DISPLAY SHELVING

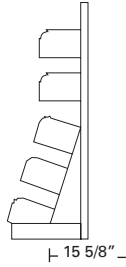

Catalog No.	Height	Adjustable Backstops	Nominal Shelf Depth
-------------	--------	----------------------	---------------------

### SINGLE FACED

ADS6636SF	66"	2	8"
ADS8436SF	84"	3	8"
ADS9036SF	90"	3	8"

Catalog No.	Height	Adjustable Backstops	Nominal Shelf Depth
-------------	--------	----------------------	---------------------

### DOUBLE FACED

ADS6636DF	66"	2	8"
ADS8436DF	84"	3	8"
ADS9036DF	90"	3	8"

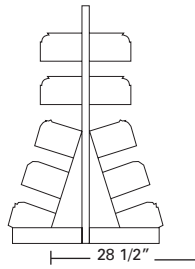

- NOTE:
- Upper closed back available.
  - End of range units available (18" or 24" width).
  - Shelf depth dimensions are nominal. For actual dimensions, deduct 1" to the nominal depth.
  - The picture is for reference only and the quantity of shelf may vary.

# MAGAZINE DISPLAY & STORAGE UNIT-BREP-1 CABINET



### PERIODICAL DISPLAY & STORAGE CABINET

This versatile, preassembled storage unit displays the current month's periodicals on 5 sloped shelves.

Display shelves swing up to expose flat shelves, each providing storage space for 4 stacks of magazines 8 1/2" x 11" up to 8" high.

72" H x 37 1/2" W x 20" D

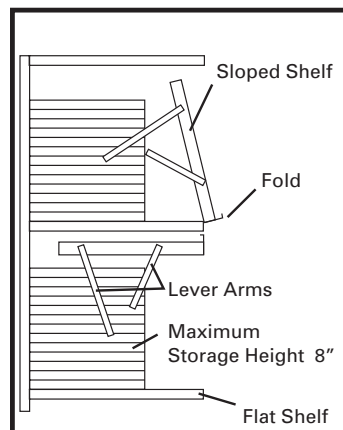

# CONTEMPORARY T-BASE UNITS



**SINGLE FACED**

	Nominal Shelf Depth	Starter Unit	Adder Unit
<b>42" HIGH</b>	<b>3 ADJUSTABLE SHELVES</b>		
	8"	TP423608S	TP423608A
	9"	TP423609S	TP423609A
	10"	TP423610S	TP423610A
	12"	TP423612S	TP423612A



**DOUBLE FACED**

	Nominal Shelf Depth	Starter Unit	Adder Unit
<b>42" HIGH</b>	<b>6 ADJUSTABLE SHELVES</b>		
	8"	TP423616S	TP423616A
	9"	TP423618S	TP423618A
	10"	TP423620S	TP423620A
	12"	TP423624S	TP423624A

<b>48" HIGH</b>	<b>3 ADJUSTABLE SHELVES</b>		
	8"	TP483608S	TP483608A
	9"	TP483609S	TP483609A
	10"	TP483610S	TP483610A
	12"	TP483612S	TP483612A

<b>48" HIGH</b>	<b>6 ADJUSTABLE SHELVES</b>		
	8"	TP483616S	TP483616A
	9"	TP483618S	TP483618A
	10"	TP483620S	TP483620A
	12"	TP483624S	TP483624A

<b>66" HIGH</b>	<b>5 ADJUSTABLE SHELVES</b>		
	8"	TP663608S	TP663608A
	9"	TP663609S	TP663609A
	10"	TP663610S	TP663610A
	12"	TP663612S	TP663612A

<b>66" HIGH</b>	<b>10 ADJUSTABLE SHELVES</b>		
	8"	TP663616S	TP663616A
	9"	TP663618S	TP663618A
	10"	TP663620S	TP663620A
	12"	TP663624S	TP663624A

<b>78" HIGH</b>	<b>6 ADJUSTABLE SHELVES</b>		
	8"	TP783608S	TP783608A
	9"	TP783609S	TP783609A
	10"	TP783610S	TP783610A
	12"	TP783612S	TP783612A

<b>78" HIGH</b>	<b>12 ADJUSTABLE SHELVES</b>		
	8"	TP783616S	TP783616A
	9"	TP783618S	TP783618A
	10"	TP783620S	TP783620A
	12"	TP783624S	TP783624A

<b>90" HIGH</b>	<b>7 ADJUSTABLE SHELVES</b>		
	8"	TP903608S	TP903608A
	9"	TP903609S	TP903609A
	10"	TP903610S	TP903610A
	12"	TP903612S	TP903612A

<b>90" HIGH</b>	<b>14 ADJUSTABLE SHELVES</b>		
	8"	TP903616S	TP903616A
	9"	TP903618S	TP903618A
	10"	TP903620S	TP903620A
	12"	TP903624S	TP903624A

- NOTE:
- Above units with painted T-Bases.
  - Chromes T-Bases available.
  - Shelf and base depth dimensions are nominal. For actual dimensions, deduct 1" to the nominal depth.
  - The picture is for reference only and the quantity of shelf may vary.
  - Caster wheels are available upon request for T-Base units.

# STEEL END PANELS

## STEEL END PANELS FOR «L» TYPE BOOKSTACKS



### SINGLE FACED

#### 42" HIGH

Catalog No.	Actual Base Shelf Depth	Panel Width
EPAS4208-PAT	7"	9 3/8"
EPAS4209-PAT	8"	10 3/8"
EPAS4210-PAT	9"	11 3/8"
EPAS4211-PAT	9"	11 3/8"
EPAS4212-PAT	11"	13 3/8"
EPAS4213-PAT	11"	13 3/8"

#### 84" HIGH

Catalog No.	Base Shelf Depth	Panel Width
EPAS8408-PAT	7"	9 3/8"
EPAS8409-PAT	8"	10 3/8"
EPAS8410-PAT	9"	11 3/8"
EPAS8411-PAT	9"	11 3/8"
EPAS8412-PAT	11"	13 3/8"
EPAS8413-PAT	11"	13 3/8"

#### 48" HIGH

Catalog No.	Actual Base Shelf Depth	Panel Width
EPAS4808-PAT	7"	9 3/8"
EPAS4809-PAT	8"	10 3/8"
EPAS4810-PAT	9"	11 3/8"
EPAS4811-PAT	9"	11 3/8"
EPAS4812-PAT	11"	13 3/8"
EPAS4813-PAT	11"	13 3/8"

#### 90" HIGH

Catalog No.	Base Shelf Depth	Panel Width
EPAS9008-PAT	7"	9 3/8"
EPAS9009-PAT	8"	10 3/8"
EPAS9010-PAT	9"	11 3/8"
EPAS9011-PAT	9"	11 3/8"
EPAS9012-PAT	11"	13 3/8"
EPAS9013-PAT	11"	13 3/8"

#### 66" HIGH

Catalog No.	Actual Base Shelf Depth	Panel Width
EPAS6608-PAT	7"	9 3/8"
EPAS6609-PAT	8"	10 3/8"
EPAS6610-PAT	9"	11 3/8"
EPAS6611-PAT	9"	11 3/8"
EPAS6612-PAT	11"	13 3/8"
EPAS6613-PAT	11"	13 3/8"

#### 93" HIGH

Catalog No.	Base Shelf Depth	Panel Width
EPAS9308-PAT	7"	9 3/8"
EPAS9309-PAT	8"	10 3/8"
EPAS9310-PAT	9"	11 3/8"
EPAS9311-PAT	9"	11 3/8"
EPAS9312-PAT	11"	13 3/8"
EPAS9313-PAT	11"	13 3/8"

#### 78" HIGH

Catalog No.	Actual Base Shelf Depth	Panel Width
EPAS7808-PAT	7"	9 3/8"
EPAS7809-PAT	8"	10 3/8"
EPAS7810-PAT	9"	11 3/8"
EPAS7811-PAT	9"	11 3/8"
EPAS7812-PAT	11"	13 3/8"
EPAS7813-PAT	11"	13 3/8"

- NOTE:
- End panels will be supplied in Patterned Steel unless otherwise specified.
  - Wood veneer, plastic laminate melamine and plain steel end panels are available. Consult factory.
  - Shelf and base depth dimensions are actual. For nominal dimensions, add 1" to the actual depth.

# STEEL END PANELS

## STEEL END PANELS FOR DIVIDER TYPE BOOKSTACKS



### End Panel Kick Strip

Optional for use with wood veneer, plastic laminate or melamine end panels.

### DOUBLE FACED

#### 42" HIGH

Catalog No.	Actual Base Shelf Depth	Panel Width
EPAD4216-PAT	14"	16 3/4"
EPAD4218-PAT	16"	18 3/4"
EPAD4220-PAT	18"	20 3/4"
EPAD4224-PAT	22"	24 3/4"
EPAD4232-PAT	30"	32 3/4"

Catalog No.	Base Shelf Depth	Panel Width
EPAD8416-PAT	14"	16 3/4"
EPAD8418-PAT	16"	18 3/4"
EPAD8420-PAT	18"	20 3/4"
EPAD8424-PAT	22"	24 3/4"
EPAD8432-PAT	30"	32 3/4"

#### 48" HIGH

EPAD4816-PAT	14"	16 3/4"
EPAD4818-PAT	16"	18 3/4"
EPAD4820-PAT	18"	20 3/4"
EPAD4824-PAT	22"	24 3/4"
EPAD4832-PAT	30"	32 3/4"

#### 90" HIGH

EPAD9016-PAT	14"	16 3/4"
EPAD9018-PAT	16"	18 3/4"
EPAD9020-PAT	18"	20 3/4"
EPAD9024-PAT	22"	24 3/4"
EPAD9032-PAT	30"	32 3/4"

#### 66" HIGH

EPAD6616-PAT	14"	16 3/4"
EPAD6618-PAT	16"	18 3/4"
EPAD6620-PAT	18"	20 3/4"
EPAD6624-PAT	22"	24 3/4"
EPAD6632-PAT	30"	32 3/4"

#### 93" HIGH

EPAD9316-PAT	14"	16 3/4"
EPAD9318-PAT	16"	18 3/4"
EPAD9320-PAT	18"	20 3/4"
EPAD9324-PAT	22"	24 3/4"
EPAD9332-PAT	30"	32 3/4"

#### 78" HIGH

EPAD7816-PAT	14"	16 3/4"
EPAD7818-PAT	16"	18 3/4"
EPAD7820-PAT	18"	20 3/4"
EPAD7824-PAT	22"	24 3/4"
EPAD7832-PAT	30"	32 3/4"

NOTE: • End panels will be supplied in Patterned Steel unless otherwise specified.  
 • Wood veneer, plastic laminate melamine and plain steel end panels available. Consult factory.  
 • Shelf and base depth dimensions are actual.

# CANOPY TOPS

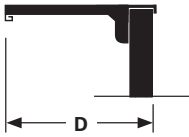

**LOWER SINGLE FACE**

**No.                      Actual Shelf Width                      Base Depth**

## SINGLE FACED

Recommended for lower sections (66" high and lower)

ACTS3608ULA	36	9 7/32
ACTS3609ULA	36	10 7/32
ACTS3610ULA	36	11 7/32
ACTS3611ULA	36	12 7/32
ACTS3612ULA	36	13 7/32
ACTS3613ULA	36	14 7/32
ACTS3616ULA	36	17 7/32

- Canopy top depth dimensions are actual
- Canopy top does cover the welded frame
- Cannot be used for double face units

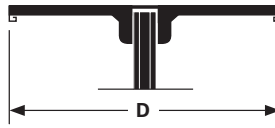

**LOWER DOUBLE FACE**

**No.                      Actual Shelf Width                      Base Depth**

## DOUBLE FACED

Recommended for lower sections (66" high and lower)

ACTD3616A	36	16 3/8
ACTD3618A	36	18 3/8
ACTD3620A	36	20 3/8
ACTD3622A	36	22 3/8
ACTD3624A	36	24 3/8
ACTD3626A	36	26 3/8
ACTD3632A	36	32 3/8

- Canopy top depth dimensions are actual
- Canopy top covers both sides
- Cannot be used for single face units

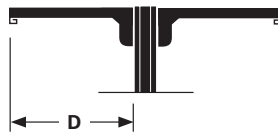
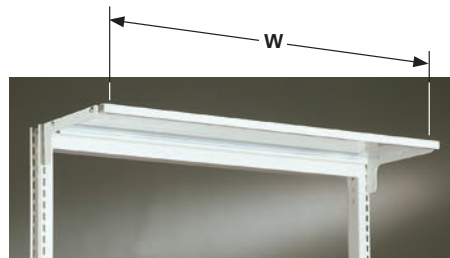

**SINGLE / DOUBLE FACE**

**No.                      Actual Shelf Width                      Base Depth**

## SINGLE FACED - DOUBLE FACED

Recommended for higher sections (78" high and higher)

ACTS3608A	36	7 7/32
ACTS3609A	36	8 7/32
ACTS3610A	36	9 7/32
ACTS3611A	36	10 7/32
ACTS3612A	36	11 7/32
ACTS3613A	36	12 7/32
ACTS3616A	36	15 7/32

- Canopy top depth dimensions are actual
- Canopy top does not cover the welded frame
- 2 canopies are required for double face units

NOTE: • Substitute 24 or 30 within catalog number when required  
 • A channel is required to use a wire book support. Call factory for more information.





## CLOSED BACK

Catalog No. Width 36"	Height
L3636BA	36"
L4236BA	42"
L4836BA	48"
L5436BA	54"
L6036BA	60"
L6636BA	66"
L7236BA	72"
L7836BA	78"
L8436BA	84"
L9036BA	90"
L9336BA	93"
L10236BA	102"

• Above may be used with divider type stacks as well.



## WALL STANDARD

Catalog No.	Height
L36WSC	36"
L42WSC	42"
L48WSC	48"
L54WSC	54"
L60WSC	60"
L66WSC	66"
L72WSC	72"
L78WSC	78"
L84WSC	84"
L90WSC	90"
L93WSC	93"
L102WSC	102"

• Two pieces type wall standard available. To order, deduct suffix «C».



## INTERMEDIATE FILLERS

Indicate Nominal Base Depth x Width of Adjacent Unit x Nominal Base Depth x Height



## CORNER FILLERS

Indicate Nominal Base Depth x Nominal Base Depth of Adjacent Unit x Height

# WELDED FRAME AND GUSSET



## SEISMIC WELDED FRAME 2 TUBES

GUSSETS NOT INCLUDED. SEE BESIDE.

Catalog No.	Height
L78362TA	78"
L84362TA	84"
L90362TA	90"
L93362TA	93"



## WELDED FRAME

Catalog No.	Height
L3636A	36"
L4236A	42"
L4836A	48"
L5436A	54"
L6036A	60"
L6636A	66"
L7236A	72"
L7836A	78"
L8436A	84"
L9036A	90"
L9336A	93"
L10236A	102"

- 24" and 30" width available.
- Substitute 24" or 30" width in catalog number.

## GUSSET SINGLE FACED RIGHT AND LEFT

Catalog No.	Base Depth
G9008SF*A	7"
G9009SF*A	8"
G9010SF*A	9"
G9012SF*A	11"

\*Specify (L) left or (R) right.

## GUSSET DOUBLE FACED

Catalog No.	Actual Base Depth
G9016DFA	14"
G9018DFA	16"
G9020DFA	18"
G9022DFA	20"
G9024DFA	22"

• Base depth dimensions are actual.



## ADJUSTABLE SHELF 36" WIDTH

Catalog No.	Actual Shelf Depth
LS3608A	7"
LS3609A	8"
LS3610A	9"
LS3612A	11"
LS3616A	15"



## BASE SHELF 36" WIDTH

Catalog No.	Actual Base Shelf Depth
L3608BSA	7"
L3609BSA	8"
L3610BSA	9"
L3612BSA	11"
L3616BSA	15"

• Double faced units require 2 base shelves.

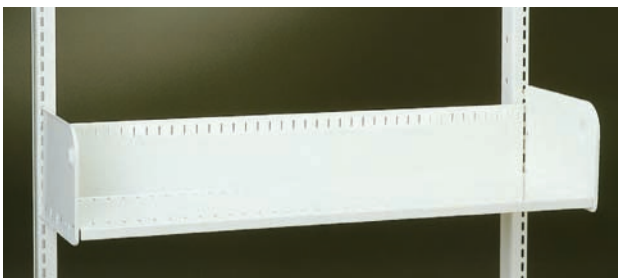

## ADJUSTABLE DIVIDER SHELF 36" WIDTH

Catalog No.	Actual Shelf Depth
FS3609A	9"
FS3611A	11"
FS3613A	13"
FS3615A	15"

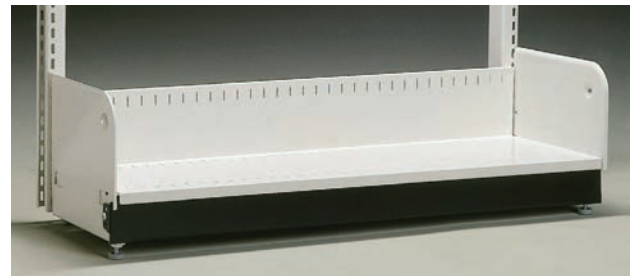

## DIVIDER TYPE BASE SHELF 36" WIDTH (WITHOUT DIVIDERS)

Catalog No.	Actual Base Shelf Depth
F3609BSA	9"
F3611BSA	11"
F3613BSA	13"
F3615BSA	15"

• Double faced units require 2 base shelves.



## DIVIDER

Catalog No.	Actual Shelf Depth
<b>6" High</b>	<b>9" High</b>
F68	F98
F610	F910
F612	F912
F614	F914



## BASE SUPPORT COVERS

Catalog No.	Base Depth
L08SC	7"
L09SC	8"
L10SC	9"
L12SC	11"

• Provides finished appearance to base supports at end of range when end panels are not used.

# SHELVES



## SLIDING REFERENCE SHELF

TYPICAL APPLICATION

(ADJ. SHELF NOT INCLUDED)

«L» Serie            L3612SRA  
«F» Serie            F3611SRA

For use on 7" to 11" shelves.  
Width of the reference shelf: 30" (actual)  
Depth of the reference shelf: 11" (actual)



## MULTI-TIER SHELF

MICROFILMS / CASSETTES / PAPERBACKS

Shelf 9" actual    L3610TTSA



## MICROFILM SHELF

4" Shelf Depth    L3604MF  
6" Shelf Depth    L3606MF



## INTEGRAL BACKSTOP SHELF



## ADJUSTABLE LOW BACK 1 1/2" HIGH SHELF / BASE

ACCEPTS SLIDING WIRE BOOK SUPPORT

	Catalog No.	Actual Shelf Depth
<b>Shelf</b>	FS3607NSA	7"
	FS3608NSA	8"
	FS3609NSA	9"
	FS3611NSA	11"
	FS3612NSA	12"
<b>Base</b>	F3607NSBSA	7"
	F3608NSBSA	8"
	F3609NSBSA	9"
	F3611NSBSA	11"
	F3612NSBSA	12"

	Catalog No.	Shelf Depth
<b>Shelf</b>	FS3607LBA	7"
	FS3608LBA	8"
	FS3609LBA	9"
	FS3611LBA	11"
	FS3612LBA	12"
<b>Base</b>	F3607LBBSA	7"
	F3608LBBSA	8"
	F3609LBBSA	9"
	F3611LBBSA	11"
	F3612LBBSA	12"

# OPTIONAL SHELVES

**Closed**



**Open**

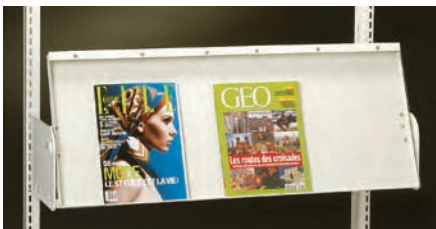

## PERIODICAL DISPLAY SHELF PIVOTED

14" high hinged display shelf with 11" deep actual storage shelf  
LS3614PHA

For 15" deep actual storage shelf  
LS3614PHA-16

## PERIODICAL DISPLAY BASE PIVOTED

14" high hinged display shelf with 11" deep actual storage shelf  
L3614PHBA

For 15" deep actual base shelf  
L3614PHBA-16

## PERIODICAL DISPLAY SHELF HINGED (BRM)

Catalog No.	Display shelf depth	Actual storage shelf depth
-------------	---------------------	----------------------------

**Shelf**

L3612BRMA-13	12"	13"
L3612BRMA-15	12"	15"
L3614BRMA-15	14"	15"

	Display shelf	Actual storage shelf
--	---------------	----------------------

**Base Shelf**

L3612BRMBSA-13	12"	13"
L3612BRMBSA-15	12"	15"
L3614BRMBSA-15	14"	15"

## PERIODICAL DISPLAY SHELF FIXED

11" actual sloped surface with 9" actual side depth

L3611PF

## HINGED PERIODICAL SHELF WITH DIVIDER STORAGE

Shelf		Actual storage shelf depth
-------	--	----------------------------

LS3614PHA-DV11		11"
LS3614PHA-DV15		15"

Base		
------	--	--

Dividers are used to create storage compartments. Dividers are optional.

## HINGED PERIODICAL SHELF WITH PLEXIGLASS COVER

Shelf		Actual storage shelf depth
-------	--	----------------------------

LS3614PHA-P		11"
LS3614PHA-16-P		15"

Base		
------	--	--

LS3614PHBA-P		11"
LS3614PHBA-16-P		15"

# SHELVES



## LOW PROFILE ADJUSTABLE SHELF

WITH 4" HIGH END BRACKETS

Catalog No.	Actual Shelf Depth
-------------	--------------------

LS3608LPA	7"
LS3609LPA	8"
LS3610LPA	9"
LS3612LPA	11"
LS3616LPA	15"

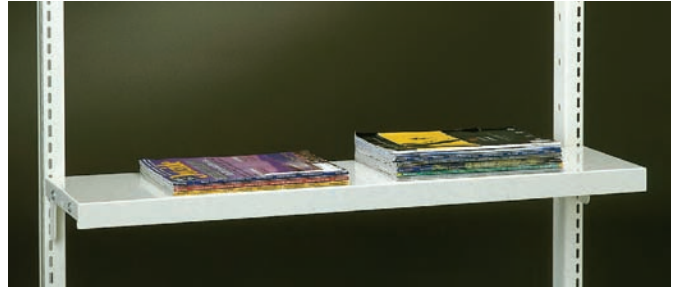

## STORAGE SHELF

Catalog No.	Actual Shelf Depth
-------------	--------------------

L3608UA	7"
L3609UA	8"
L3610UA	9"
L3612UA	11"
L3616UA	15"
U3618A	17"
U3622A	21"

# UNIVERSAL DISPLAY SHELF

FOR DISPLAY: VIDEO TAPES, AUDIO TAPES, EASY BOOKS, ART BOOKS, NEW ISSUES



## UNIVERSAL DISPLAY

	Catalog No.	Actual Shelf Depth
--	-------------	--------------------

<b>Shelf</b>	LS3610UDA	9"
<b>Base</b>	L3610UDBSA	9"
	L3612UDBSA	11"



## UNIVERSAL DISPLAY DIVIDER

DIVIDERS OPTIONAL - F57 DIVIDERS REQUIRED

	Catalog No.	Actual Shelf Depth
--	-------------	--------------------

<b>Shelf</b>	FS3609UDA	9"
<b>Base</b>	F3609UDBSA	9"
	F3611UDBSA	11"



## PAPER BACK DISPLAY SHELF

INCLUDES 5 DIVIDERS

11" Shelf LP2A

• Shelf and base depth dimensions are actual.



## ADJUSTABLE SHELF BACKSTOP

3" High

L36X



## COMPACT DISK SHELF

Catalog No.

Shelf Depth

F3612MBA

12"



## RECESSED SHELF BACKSTOP

3" High

L36RX



## BROWSING BOX

For: video tapes, compact discs, cassettes, picture books, paperbacks

36"W x 11"D x 7 1/2"H L3612BBA

36"W x 15"D x 7 1/2"H L3616BBA



## PAPER BACK

Display Insert

L36PDA

Typical Application  
(Shelf not Included)

# SHELVES



**SUPPORTS FOR WORK SHELF**  
 FOR LAMINATED PLASTIC TOP 21" ACTUAL  
 Brackets (Pair)      LTB19



**HANGING BAG SHELVING**  
 FOR VARIOUS OBJECTS  
 11" Depth      L12RODA



**ADJUSTABLE WIRE BACKSTOP  
 FOR WIRE BOOK SUPPORT**

3" High      L36XWB



**NEWSPAPER RACK**

(DOWELS NOT INCLUDED)

For 6 Dowels      LNB36      13 1/2" (total height)  
 For 10 Dowels      LNB36-10      21 3/4" (total height)





## FIXED MEDIA BROWSING BOX

WITH 6 DIVIDER RODS, 5 STORAGE SPACES

**Catalog No.**                      **Shelf Depth**

F3611FDA                      11"



## PULL OUT MEDIA BROWSING BOX

WITH 6 DIVIDER RODS, 5 STORAGE SPACES

**Catalog No.**                      **Shelf Depth**

F3611SDA                      11"



## SLIDING DRAWER WITH SINGLE TRAY

WITH 6 DIVIDERS

**Catalog No.**                      **Shelf Depth**                      **Height**

F3611STDA                      11"                      7"



## SLIDING DRAWER WITH DOUBLE TRAY

WITH 6 DIVIDERS

**Catalog No.**                      **Shelf Depth**                      **Height**

F3611DTDA                      11"                      7"



## SLOPED DISPLAY SHELF

WITH FRONT EDGE 3"

**Catalog No.**                      **Hinged display Shelf depth**

L3611LPF                      11"



## PERIODICAL DISPLAY TILT-UP

**Catalog No.**                      **Actual Shelf Depth**

LS3614PDTU                      15"



## MEDIA SHELF SINGLE TIER

DIVIDERS OPTIONAL - FMS67 DIVIDERS REQUIRED

**Shelf**                      **Catalog No.**                      **Shelf Depth**

FS3608MSA                      8"

FS3609MSA                      9"

**Base**                      **Catalog No.**                      **Shelf Depth**

F3608MSBA                      8"

F3609MSBA                      9"

F3611MSBA                      11"



## MEDIA SHELF DOUBLE TIER

DIVIDERS OPTIONAL - FMS67 DIVIDERS REQUIRED

**Catalog No.**                      **Shelf Depth**                      **Shelf Height**

FS3615MSA                      15"                      17"

# COMPONENTS

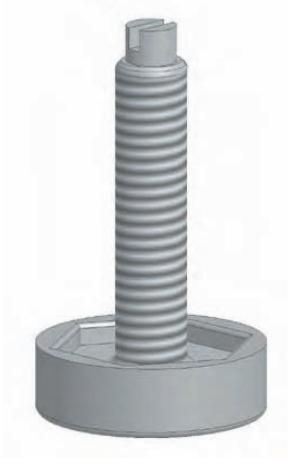

## LEVELING FEET

19.200.005.01

The leveler is not provided with the plastic cap, we are offering it separately.



## SHIM SET

Used to slope shelf 307349

Catalog No.	Actual shelf depth	Slope degree
-------------	--------------------	--------------

19.702.416.07	7" - 8"	5°
19.702.416.09	9" - 10"	5°
19.702.416.11	11" - 12"	5°
19.702.416.15	15"	5°
19.702.418.09	9"	12°
19.702.418.10	10"	12°
19.702.418.11	11"	12°
19.702.418.12	12"	12°



## STACK REINFORCEMENT

Top tie strut 7'-6" long TTS92



## COLUMN EXTENSION

Contact factory for details.



**CARD HOLDER**

Plastic self adhering      19.700.912.01  
 Labels (Qty 10)              C38.687.001



**WALL ANCHOR ANGLE**

2" x 3"                      LWAA



**RANGE FINDER**

Aluminum double faced      L2RFA



**BRACKETS**

FOR WOOD OR PLASTIC TOPS

Catalog No.	Actual Shelf Depth
L08UWT2	7"
L09UWT2	8"
L10UWT2	9"
L12UWT2	11"



**FLOOR ANCHOR ANGLE**

(HARDWARE INCLUDED)  
 19.200.026.01

## CANOPY LIGHTING



### OVERHEAD AISLE LIGHTING

Catalog No.	Width
40.240.214.01	36"
40.240.213.01	48"

- CSA and UL approved.
- Contact factory for technical details.



## ACCESSORIES



### CANOPY SIGNAGE

Catalog No.	Width	Height
L36CLH	36"	3"
L30CLH	30"	3"
L24CLH	24"	3"



**WIRE BOOK SUPPORT**

L8-9XWB  
L10-12XWB

Adjustable wire backstop sold separately (see p.21)



**SLIDING WIRE BOOK SUPPORT**

L8-9LBWB

For 1 1/2" adjustable low back shelf (see p.17)



**WIRE BOOK SUPPORTS**

7" - 9" Shelves	L8W	W Type
10" - 11" Shelves	L12W	W Type
7" - 11" Shelves	L8-12W	V Type

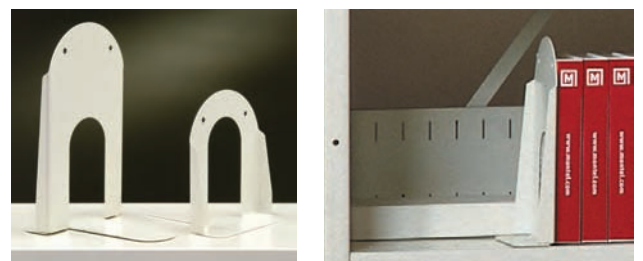

**FINDABLE BOOK SUPPORTS**

	With Plain Base	With Cork Bottom	With Magnetic Bottom
<b>6" High</b>	LM6S	LM6S CORK	LM6S MAG
<b>9" High</b>	LM9S	LM9S CORK	LM9S MAG



**BOOKTRUCK BCL-A**

(2 SLOPED SHELVES AND 1 PLAIN SHELF)



**BOOKTRUCK BCL-B**

(3 PLAIN SHELVES)

# PARTIAL LIST OF MONTEL AETNASTAK PROJECTS

## Educational Institutions

Brevard Community College, Cocoa, FL  
Brigham Young University Harold B. Lee Library, Provo, UT  
Bryant College, Smithfield, RI  
Carlsbad High School, Carlsbad, CA  
Cornell University, Ithaca, NY  
Dartmouth College, Dartmouth, NH  
Desert Hot Springs Middle School, Desert Hot Springs, CA  
Ferris State University, Big Rapids, MI  
Hazel McCallion Academic Learning Center, University of Toronto, Mississauga, ON (LEED Project)  
Iowa State University, Ames, IA  
Penn State Dickinson School of Law, Carlisle, PA  
Princeton University, Princeton, NJ  
Rice University, Houston, TX  
Stanford University Clinical Sciences, Palo Alto, CA  
Stockdale High School, Bakersfield, CA  
Texas A & M, College Station, TX  
Texas Tech University, Lubbock, TX  
Texas Women's University Main Public Library, Denton, TX  
University of British Columbia, Vancouver, BC  
U.C. Berkeley, Berkeley, CA  
U.C. Riverside, Riverside, CA  
U.C.S.F., San Francisco, CA  
U.C.S.D., San Diego, CA  
University of Houston, Houston, TX  
University of Michigan, Ann Arbor, MI  
University of Oklahoma, Oklahoma City, OK  
University of Quebec at Montreal, Montreal, QC  
University of Texas - Pan American, Edinburg, TX  
West Indio Middle School, Indio, CA  
Widener University School of Law, Wilmington, DE  
Yale University, New Haven, CT

## Libraries

Beverly Hills Public Library, Beverly Hills, CA  
Centennial Hills Library, Las Vegas, NV  
Chicago Public Library System, Chicago, IL  
Corona Public Library, Corona, CA  
Durango Public Library, Durango, CO  
Fort Pierce Main Library, Fort Pierce, FL  
Grande Bibliothèque of Quebec, Montreal, QC  
Mississippi State Law Library, Jackson, MS  
Orlando Public Library, Orlando, FL  
Richmond Public Library, Richmond, BC  
San Francisco Main Public Library, San Francisco, CA  
The Library of Congress, Washington, DC  
Vancouver Public Library, Vancouver, BC  
West Melbourne Public Library, Melbourne, FL  
Whistler Public Library, Whistler, BC  
Yuma County Library District, AZ





## A Word about our Company

Established in 1924, Montel Inc. is the pioneer of high-density mobile shelving storage system solutions in North America. Manufacturer of products for corporate, institutional, library, museum, government, healthcare, military, industrial and retail applications, Montel's achievements include some of the most prestigious projects in North America and around the world. The company serves clients through a network of Authorized Distributors throughout North America, Latin America, Europe, Africa and the Middle East.

For more information about our products and services or to see a list of Authorized Distributors, please visit us at [www.montel.com](http://www.montel.com) or call 877.935.0236.



# MONTEL®

The Intelligent Use of Space

877-935-0236

[system@montel.com](mailto:system@montel.com) - [www.montel.com](http://www.montel.com)

